

SIGN	REVISION	DATE	B Y
1	Renewal	111101	R. T
2	Renewal	160408	W. S

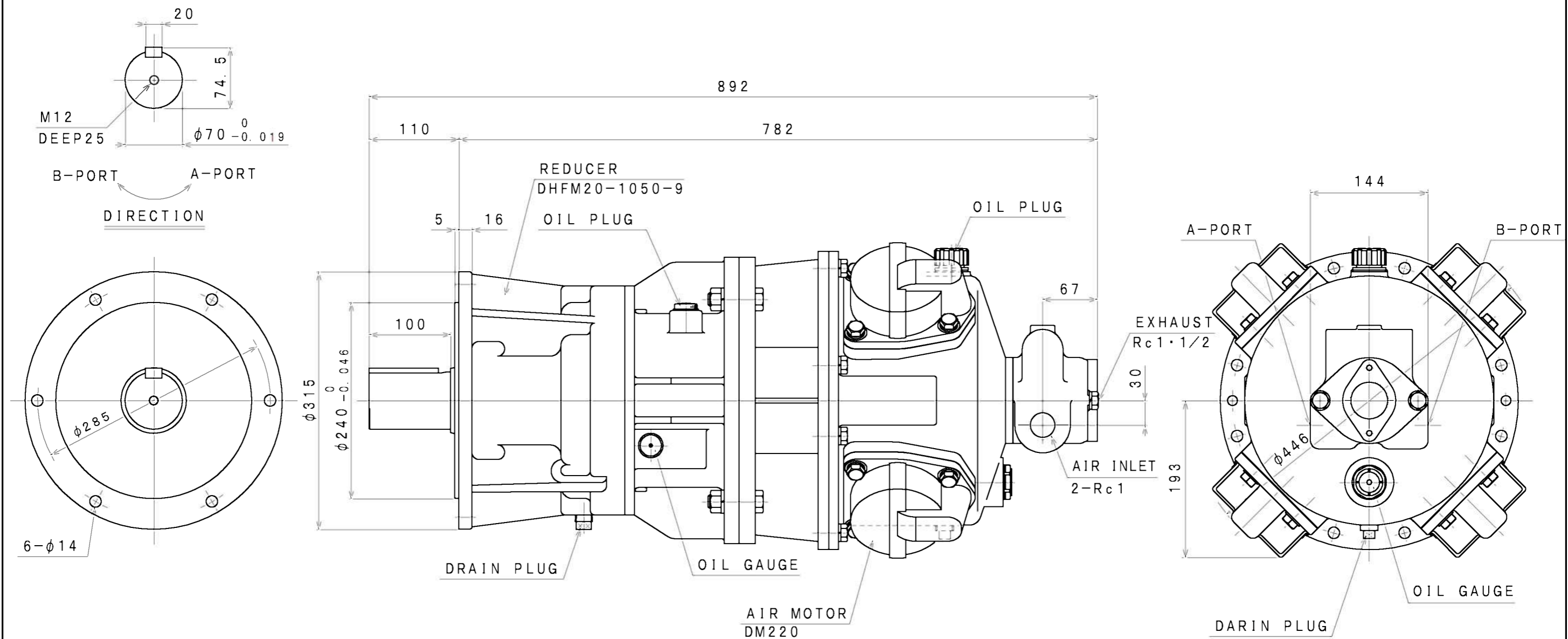

SPECIFICATION

AIR PRESSURE (MPa)	AT MAXIMUM OUTPUT				* ALLOWABLE SHAFT LOAD		LUBRICATING OIL		MASS (kg)
	OUTPUT (kW)	SPEED (rpm)	TORQUE (N·m)	AIR CONSUMPTION (m ³ /min (nor))	RADIAL (kN)	THRUST (kN)	AIR MOTOR	REDUCER	
0.6	6.98	79	844	5.4	11.7	-	JIS K2213-1 Turbine Oil	JIS K2219 Gear Oil	about 166
0.5	5.88	74	759	4.8			ISO VG32	ISO VG220	
0.4	4.80	69	665	4.1			(850cc)	(900cc)	

*:At Mid of Shaft

APPROVED	CHECKED	REVIEWED	DRAWN	PARTICULARS	OUTLINE	DATE	OCT. 08. 2010
M. M	M. S	K. S	R. T	MODEL	DM220-F-1050-9	NOTE	
					AIR MOTOR		
SAN-EI SEIKI SEISAKUSHO CO., LTD.					DWG. NO.	E310-531	SCALE 1/5