

SIGN	REVISION	DATE	BY
△1	Renewal	111101	R. T
△2	Renewal	160406	W. S

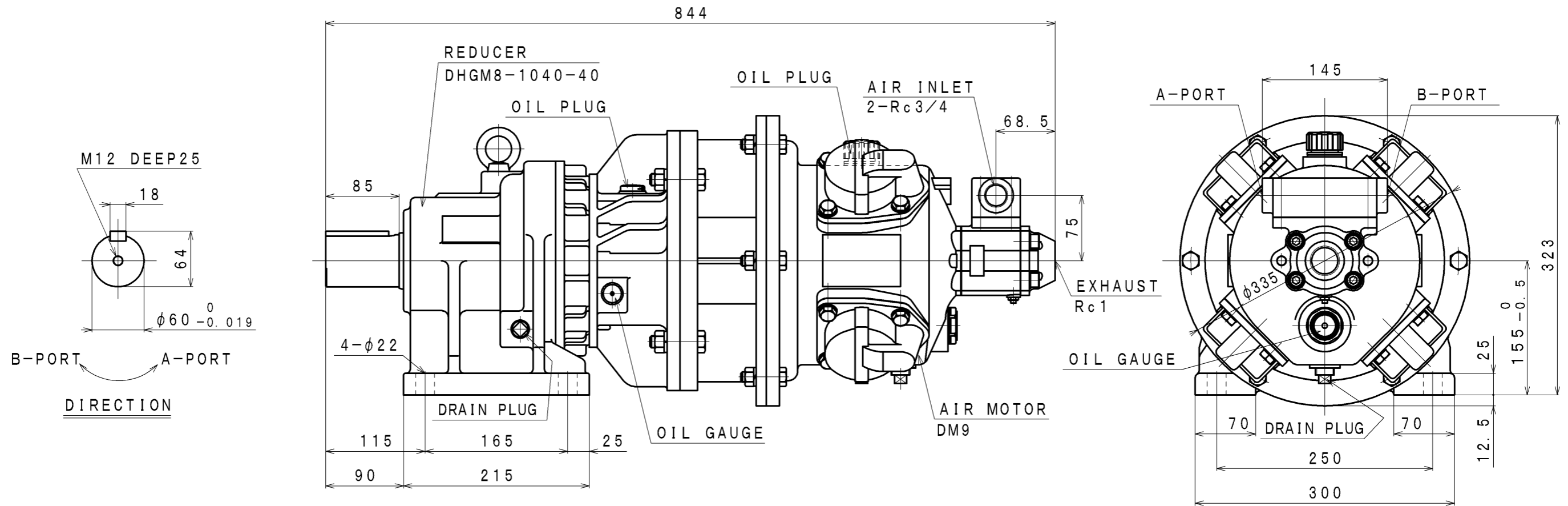

**SPECIFICATION**

AIR PRESSURE (MPa)	AT MAXIMUM OUTPUT				* ALLOWABLE SHAFT LOAD		LUBRICATING OIL		MASS (kg)
	OUTPUT (kW)	SPEED (rpm)	TORQUE (N·m)	AIR CONSUMPTION (m <sup>3</sup> /min (nor))	RADIAL (kN)	THRUST (kN)	AIR MOTOR	REDUCER	
0.6	3.79	27	1341	3.7	12.0	-	JIS K2213-1 Turbine Oil	JIS K2219 Gear Oil	about 112
0.5	3.00	25	1146	3.4			ISO VG32	ISO VG220	
0.4	2.44	23	1012	2.9			(1000cc)	(800cc)	

\*:At Mid of Shaft

APPROVED	CHECKED	REVIEWED	DRAWN	PARTICULARS	OUTLINE	DATE	OCT. 07. 2010
M. M	M. S	K. S	R. T	MODEL	DM9-G-1040-40	NOTE	
					AIR MOTOR		
SAN-EI SEIKI SEISAKUSHO CO., LTD.					DWG. NO.	E310-554	SCALE 1/5