

SIGN	REVISION	DATE	B Y
△1	Renewal	100302	W. S
△2	Correction	101222	R. T
△3	Renewal	111028	R. T
△4	Renewal	130523	W. S

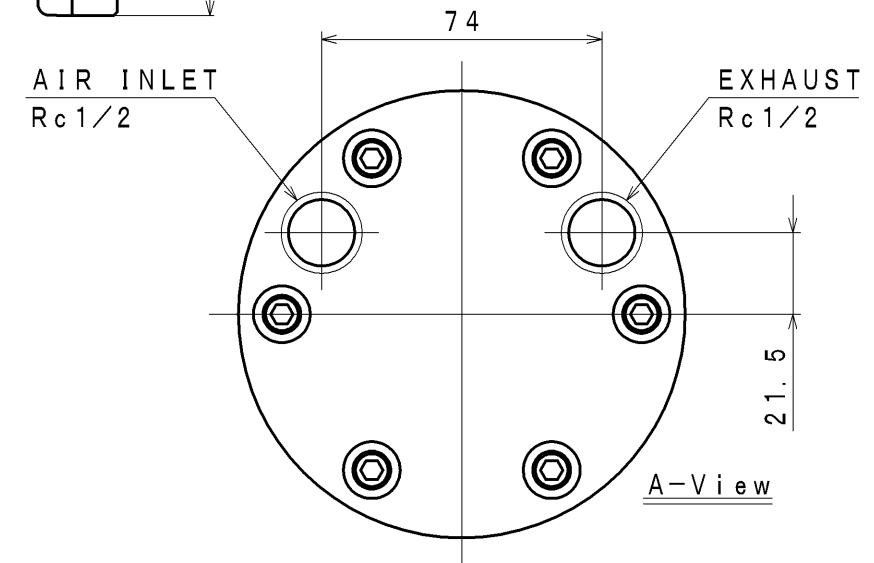
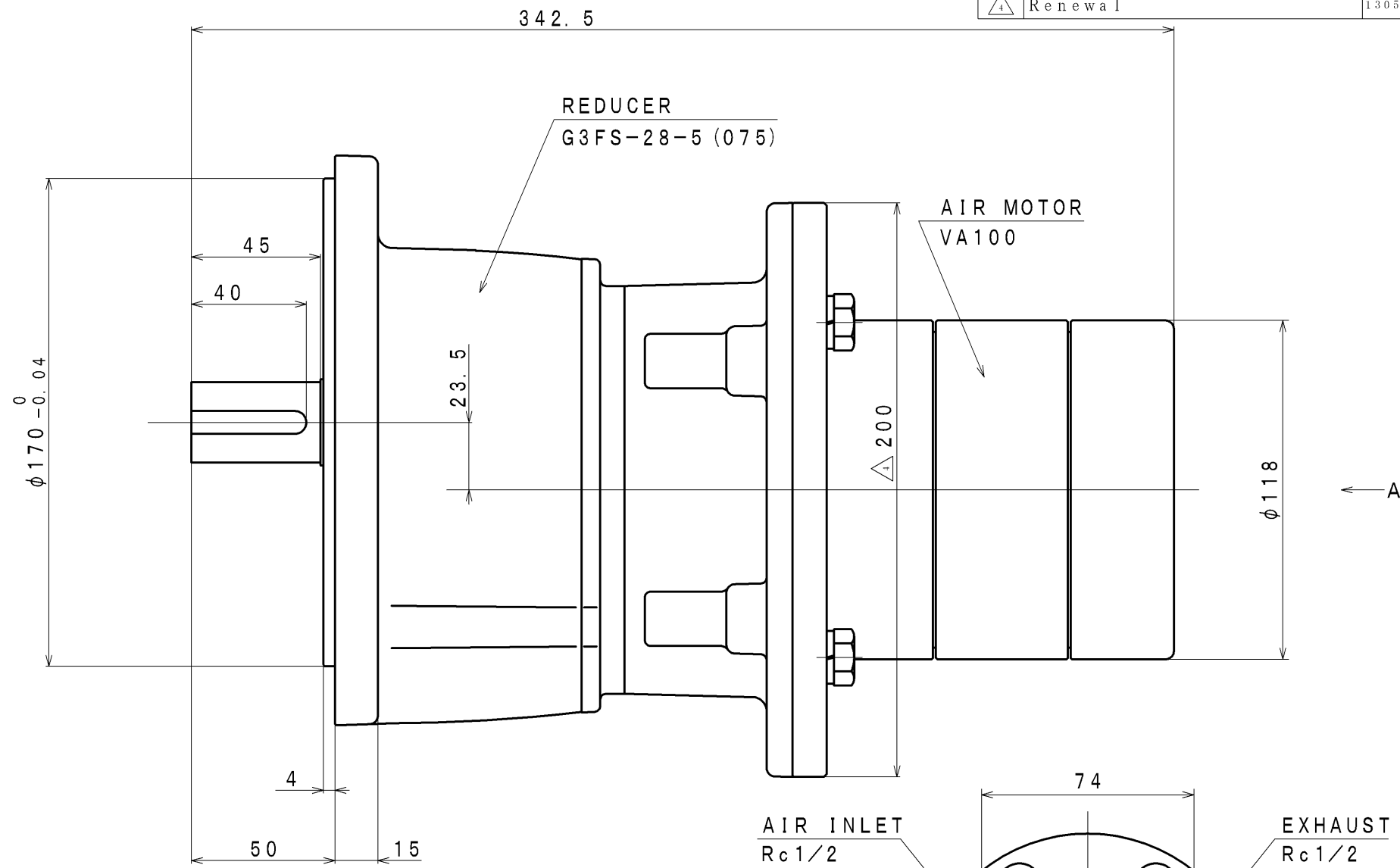
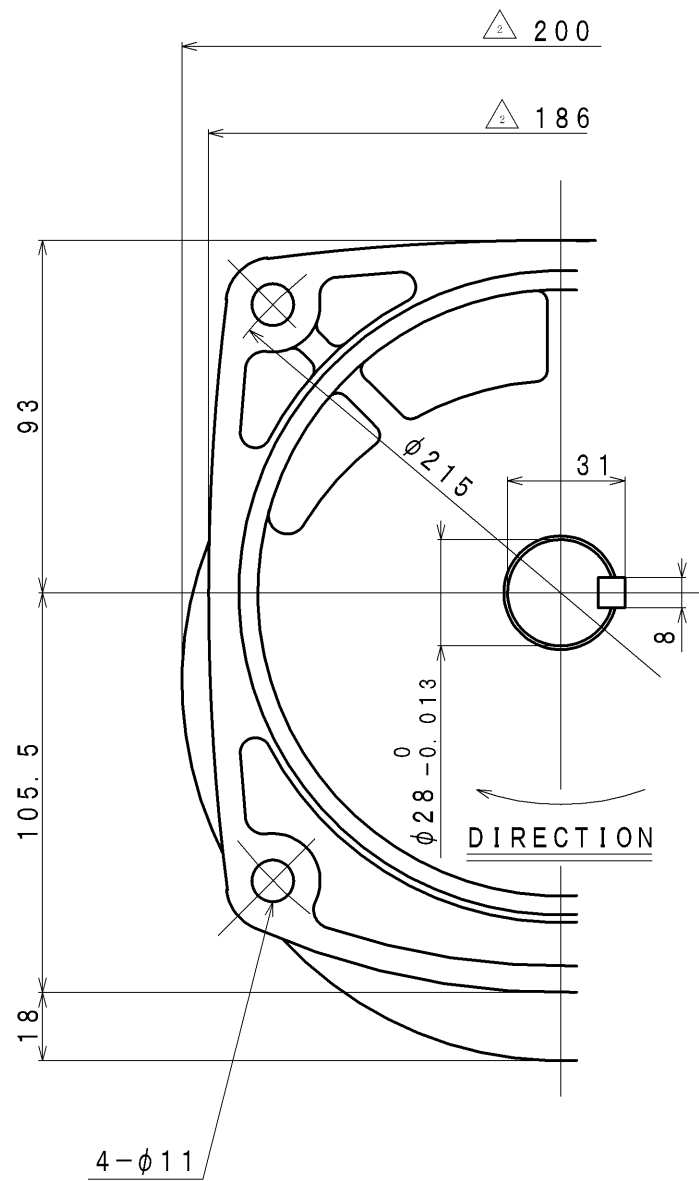

SPECIFICATION

AIR PRESSURE	AT MAXIMUM OUTPUT				※ ALLOWABLE SHAFT LOAD		LUBRICATING OIL	MASS
	OUTPUT	SPEED	TORQUE	AIR CONSUMPTION	RADIAL	THRUST		
(MPa)	(kW)	(rpm)	(N·m)	(m ³ /min (nor))	(N)	(N)	AIR MOTOR (Line Oiler)	(kg)
0.6	0.78	392	19.0	1.52	490	294	△ JIS K2213-1 Turbine Oil ISO VG32 (Line Oiler Dripping Quantity: 3~4 drop/min)	about 16.4
0.5	0.64	360	16.9	1.30				
0.4	0.51	324	15.0	1.08				

※: At Mid of Shaft

APPROVED	CHECKED	REVIEWED	DRAWN	PARTICULARS	OUTLINE DRAWING	DATE	APR. 27. 2009
M. M		W. S		MODEL	VA100L-F005	NOTE	
					AIR MOTOR	Z96-093	
SAN-EI SEIKI SEISAKUSHO CO., LTD.				DWG. NO.	E308-237	SCALE	1/2