

SIGN	REVISION	DATE	B Y
△1	Renewal	100225	W. S
△2	Correction	100910	M. S
△3	Renewal	111028	R. T
△4	Renewal	130523	W. S

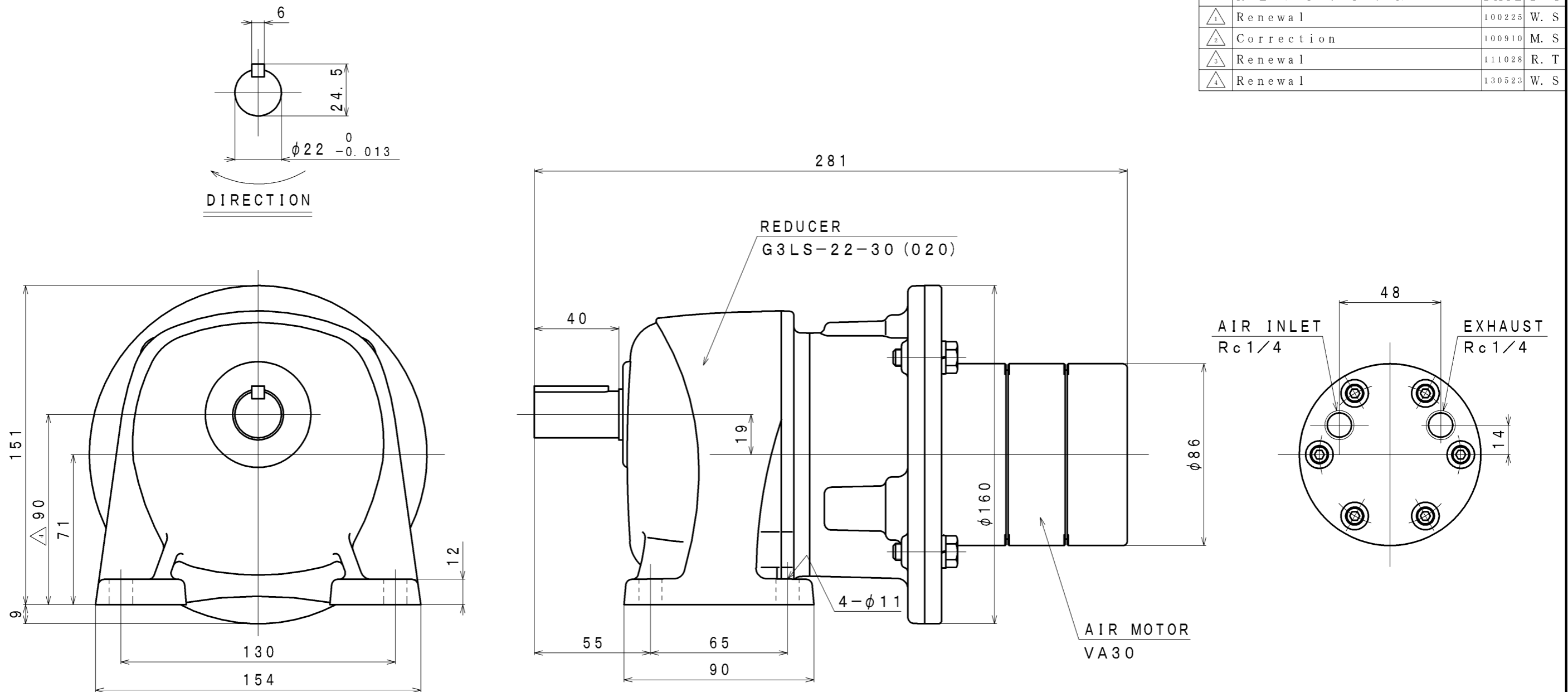

SPECIFICATION

AIR PRESSURE	AT MAXIMUM OUTPUT				* ALLOWABLE SHAFT LOAD		LUBRICATING OIL	MASS
	OUTPUT	SPEED	TORQUE	AIR CONSUMPTION	RADIAL	THRUST	AIR MOTOR (Line Oiler)	
(MPa)	(kW)	(rpm)	(N·m)	(m ³ /min (nor))	(N)	(N)	△ JIS K2213-1 Turbine Oil ISO VG32 (Line Oiler Dripping Quantity: 1~2 drop/min)	(kg)
0.6	0.23	65	34.1	0.48	1520	785		△ about 8.4
0.5	0.19	60	31.0	0.40				
0.4	0.16	54	27.8	0.33				

*: At Mid of Shaft

APPROVED	CHECKED	REVIEWED	DRAWN	PARTICULARS	OUTLINE DRAWING	DATE	JAN. 15. 2009
M. M		W. S		MODEL	VA30L-B030	NOTE	
					AIR MOTOR	Z96-091	
SAN-EI SEIKI SEISAKUSHO CO., LTD.					DWG. NO.	E308-256	SCALE
						△4	1/2