

SIGN	REVISION	DATE	B Y
△	Q-661, Renewal	121009	W. S

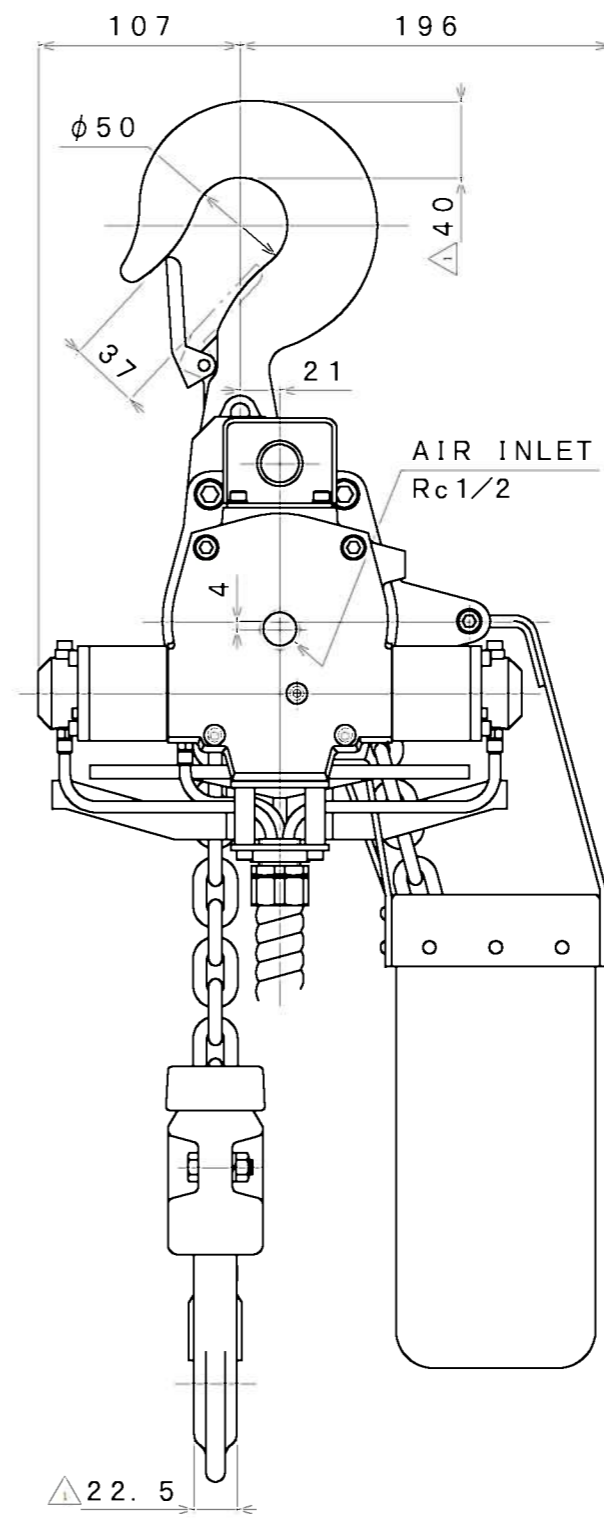
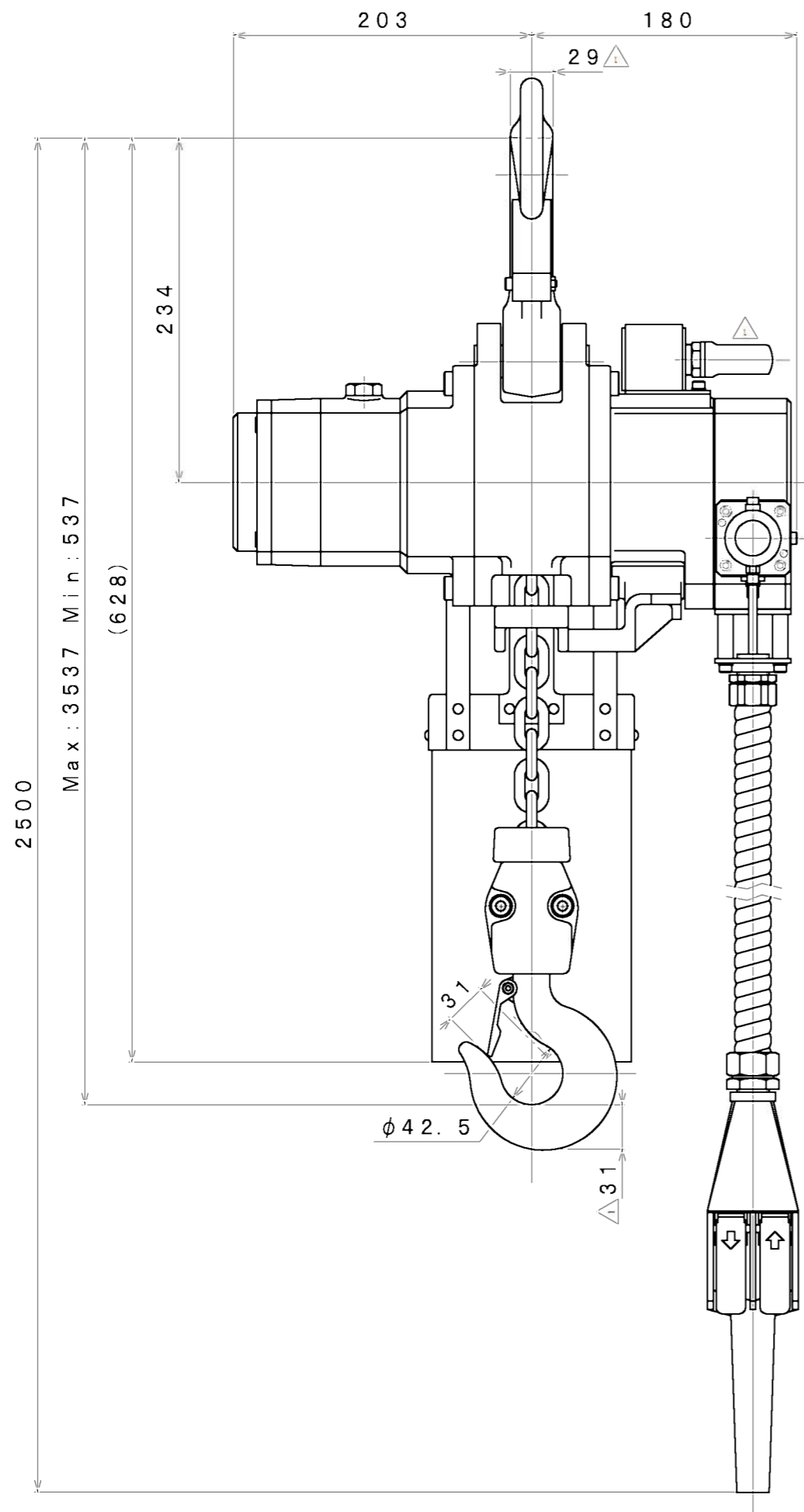

SPECIFICATION

AIR PRESSURE	(MPa)	0.4	0.5	0.6
CAPACITY	(kg)	1000		
LIFTING SPEED	(m/min)	3.0	4.0	5.0
△ AIR CONSUMPTION	(m ³ /min (nor))	1.0	1.3	1.6
LIFT	(m)	3		
MASS	(kg)	about 40		

APPROVED	CHECKED	REVIEWED	DRAWN	PARTICULARS	OUTLINE	DATE	SEP. 11. 2001
M. S	K. S	R. T	W. S	MODEL	VMX100LP	NOTE	
					AIR HOIST		
SAN-EI SEIKI SEISAKUSHO CO., LTD.					DWG. NO.	E301-195	SCALE 1/4