

SIGN	REVISION	DATE	B Y
△1	Renewal	111103	R. T
△2	Correction	120323	R. T
△3	Renewal	150406	W. S

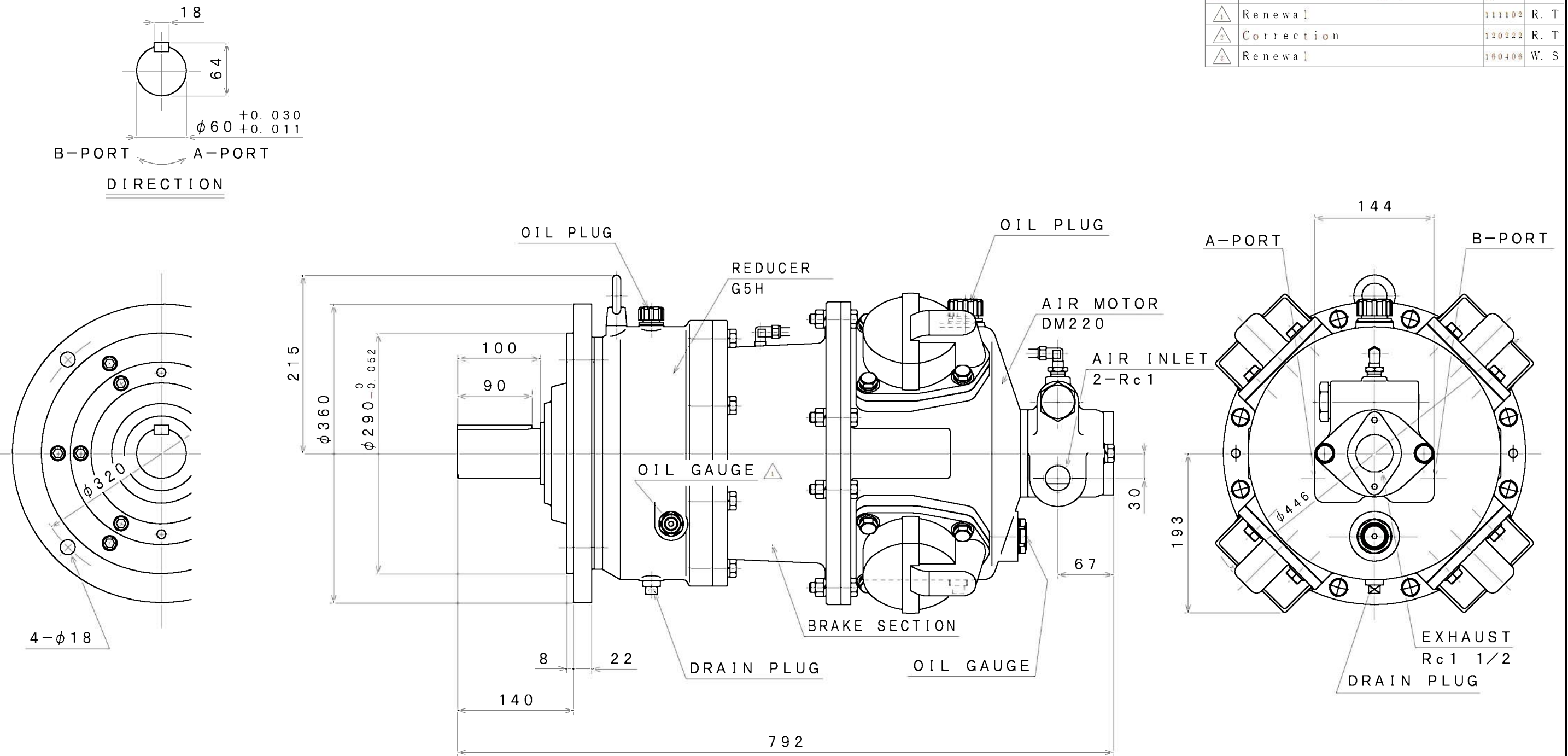

SPECIFICATION

AIR PRESSURE	AT MAXIMUM OUTPUT				※ ALLOWABLE SHAFT LOAD		LUBRICATING OIL		MASS
	OUTPUT	SPEED	TORQUE	AIR CONSUMPTION △1	RADIAL	THRUST	AIR MOTOR	REDUCER	
(MPa)	(kW)	(rpm)	(N·m)	(m ³ /min (nor))	(kN)	(kN)	△1 JIS K2213-1 Turbine Oil	JIS K2219 Gear Oil	(kg)
0.6	6.74	200	322	5.4	6.2	1.4	ISO VG32 (850cc)	ISO VG220 (600cc)	△2 about 219
0.5	5.62	180	298	4.8					
0.4	4.65	170	261	4.1					

※: At Mid of Shaft

APPROVED	CHECKED	REVIEWED	DRAWN	PARTICULARS	OUTLINE DRAWING	DATE	JAN. 09. 2010
M. M		W. S		MODEL	DM220BG5H4F	NOTE	
					AIR MOTOR	Z98-029	
SAN-EI SEIKI SEISAKUSHO CO., LTD.					DWG. NO.	E310-029	SCALE 1/5