

SIGN	REVISION	DATE	B Y
△1	Renewal	111101	R. T
△2	Renewal	160406	W. S

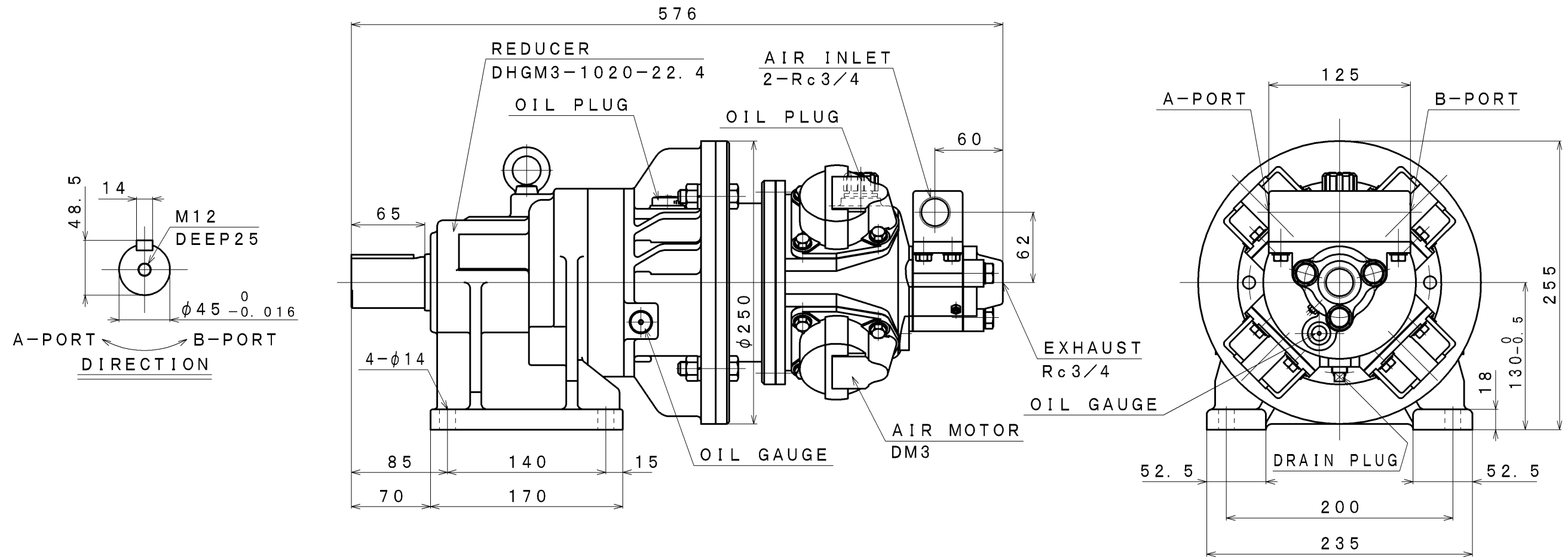

SPECIFICATION

AIR PRESSURE (MPa)	AT MAXIMUM OUTPUT				* ALLOWABLE SHAFT LOAD		LUBRICATING OIL		MASS (kg)
	OUTPUT (kW)	SPEED (rpm)	TORQUE (N·m)	AIR CONSUMPTION (m ³ /min (nor))	RADIAL (kN)	THRUST (kN)	AIR MOTOR	REDUCER	
0.6	1.65	65	242	2.0	5.4	-	JIS K2213-1 Turbine Oil	JIS K2219 Gear Oil	about 53
0.5	1.36	58	224	1.7			ISO VG32	ISO VG220	
0.4	1.07	51	201	1.4			(110cc)	(400cc)	

*:At Mid of Shaft

APPROVED	CHECKED	REVIEWED	DRAWN	PARTICULARS	OUTLINE	DATE	OCT. 06. 2010
M. M	M. S	K. S	R. T	MODEL	DM3-G-1020-22.4	NOTE	
					AIR MOTOR		
SAN-EI SEIKI SEISAKUSHO CO., LTD.					DWG. NO.	E310-548	SCALE 1/4