

SIGN	REVISION	DATE	B Y
△1	Renewal	111103	R. T
△2	Correction	120222	R. T
△3	Renewal	150406	W. S

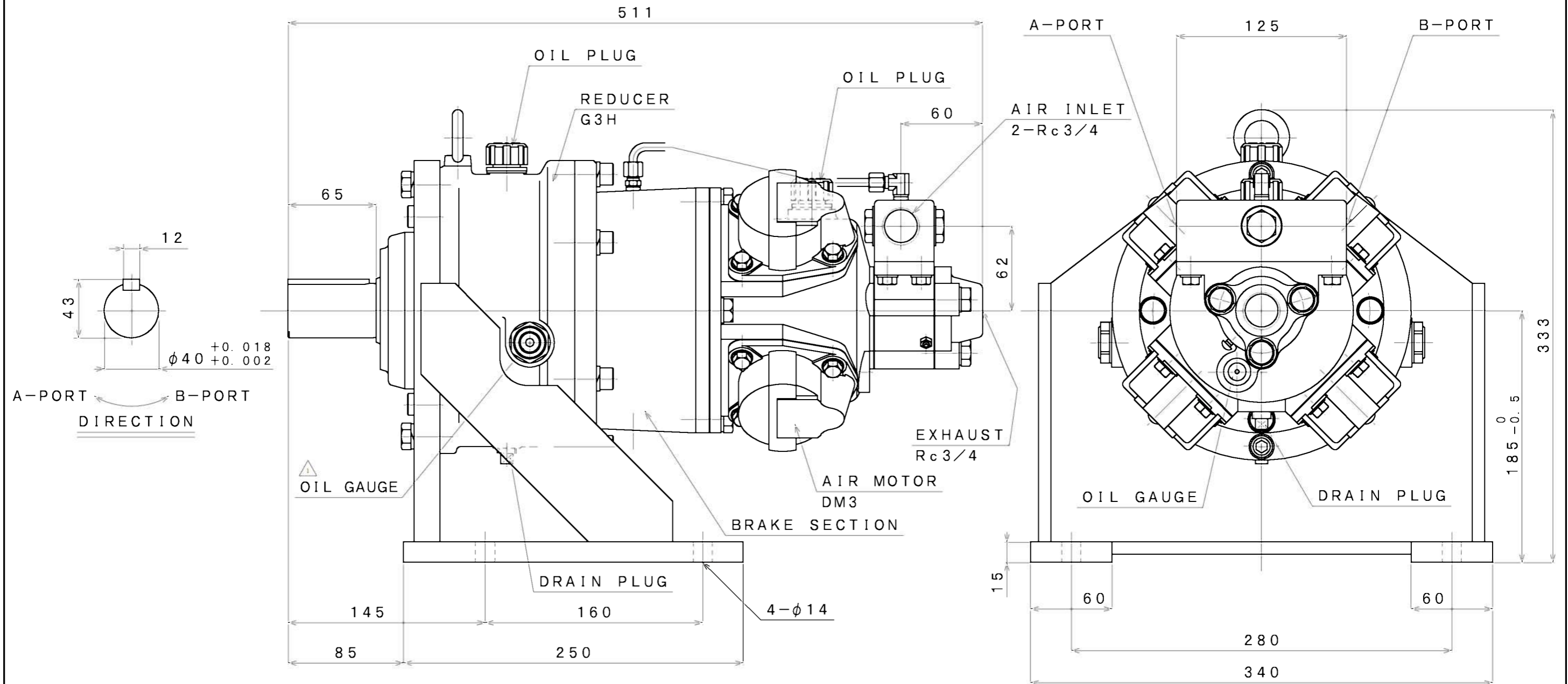

SPECIFICATION

AIR PRESSURE (MPa)	AT MAXIMUM OUTPUT				* ALLOWABLE SHAFT LOAD		LUBRICATING OIL		MASS (kg)
	OUTPUT (kW)	SPEED (rpm)	TORQUE (N·m)	AIR CONSUMPTION (m ³ /min (nor))	RADIAL (kN)	THRUST (kN)	AIR MOTOR	REDUCER	
0.6	1.65	180	87.5	2.0	3.4	0.5	△1 JIS K2213-1 Turbine Oil	JIS K2219 Gear Oil	△2 about 75
0.5	1.31	160	78.3	1.7			ISO VG32 (110cc)	ISO VG220 (150cc)	
0.4	1.05	140	71.6	1.4					

*:At Mid of Shaft

APPROVED	CHECKED	REVIEWED	DRAWN	PARTICULARS	OUTLINE DRAWING	DATE	JAN. 08. 2010
M. M		W. S		MODEL	DM3BG3H8B	NOTE	
					AIR MOTOR	Z97-075	
SAN-EI SEIKI SEISAKUSHO CO., LTD.				DWG. NO.	E310-025	SCALE	1/3