

SIGN	REVISION	DATE	BY
1	Renewal	111102	R. T
2	Renewal	160407	W. S

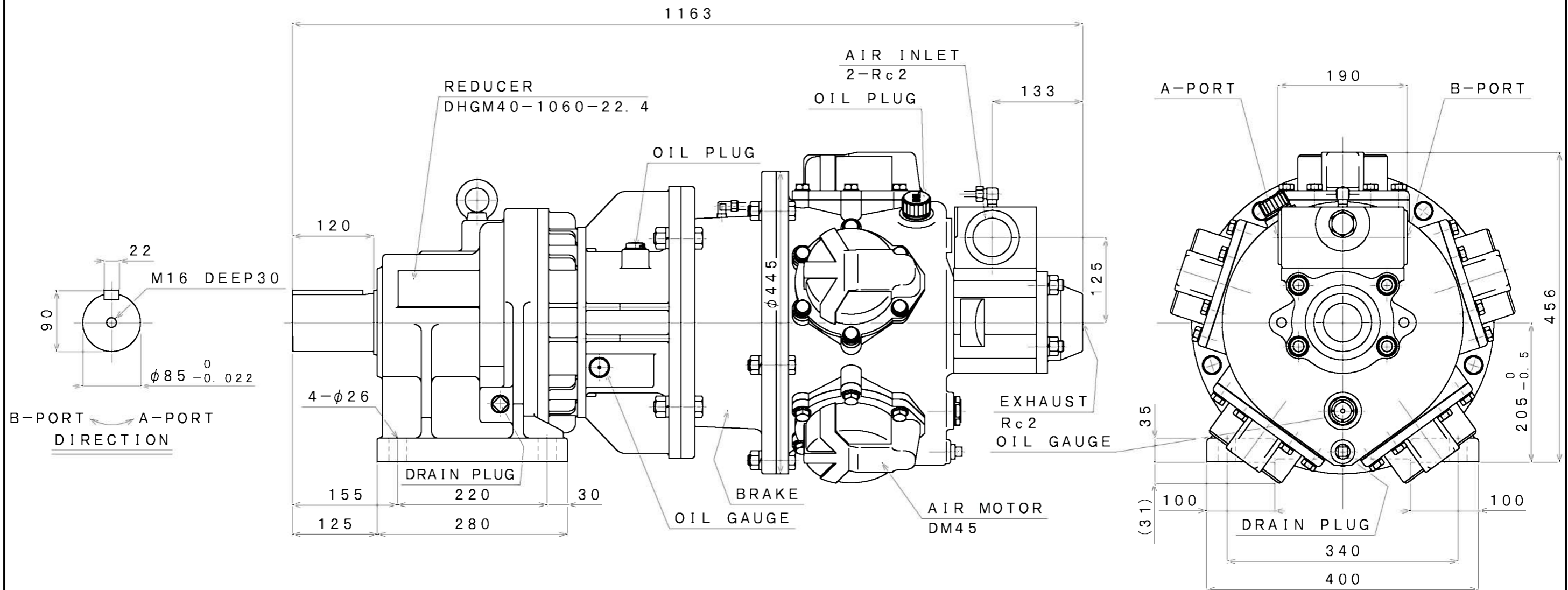

SPECIFICATION

AIR PRESSURE (MPa)	AT MAXIMUM OUTPUT				* ALLOWABLE SHAFT LOAD		LUBRICATING OIL		MASS (kg)
	OUTPUT (kW)	SPEED (rpm)	TORQUE (N·m)	AIR CONSUMPTION (m ³ /min (nor))	RADIAL (kN)	THRUST (kN)	AIR MOTOR	REDUCER	
0.6	17.04	40	4068	17.0	24.4	-	JIS K2213-1 Turbine Oil	JIS K2219 Gear Oil	about 343
0.5	13.53	37	3492	14.0			ISO VG32	ISO VG220	
0.4	10.77	35	2938	12.0			(1400cc)	(2200cc)	

*:At Mid of Shaft

APPROVED	CHECKED	REVIEWED	DRAWN	PARTICULARS	OUTLINE	DATE	OCT. 12. 2010
M. M	M. S	K. S	R. T	MODEL	DM45B-G-1060-22.4	NOTE	
					AIR MOTOR		
SAN-EI SEIKI SEISAKUSHO CO., LTD.					DWG. NO.	E310-612	SCALE 1/6