

SIGN	REVISION	DATE	B Y
△1	Renewal	100302	W. S
△2	Renewal	111028	R. T
△3	Renewal	130523	W. S

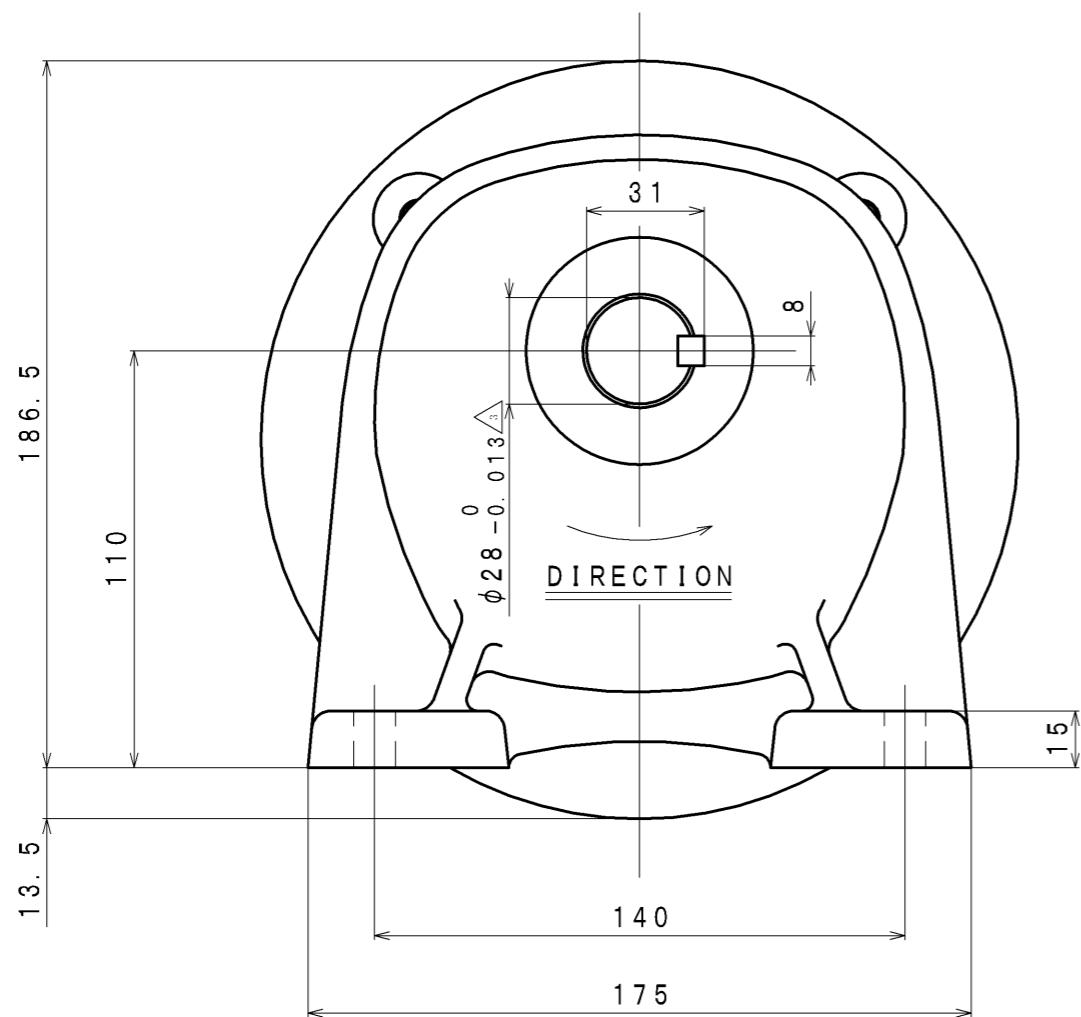

REDUCER

G3LS-28-20 (075)

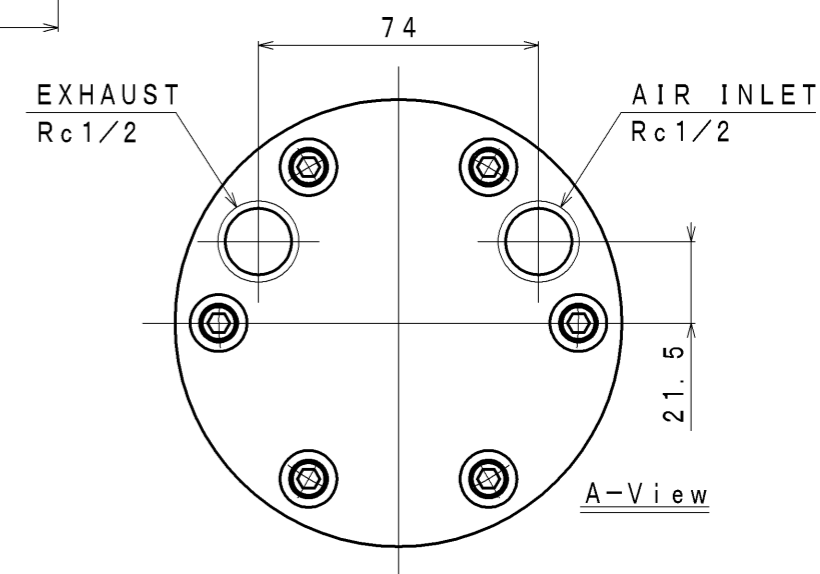
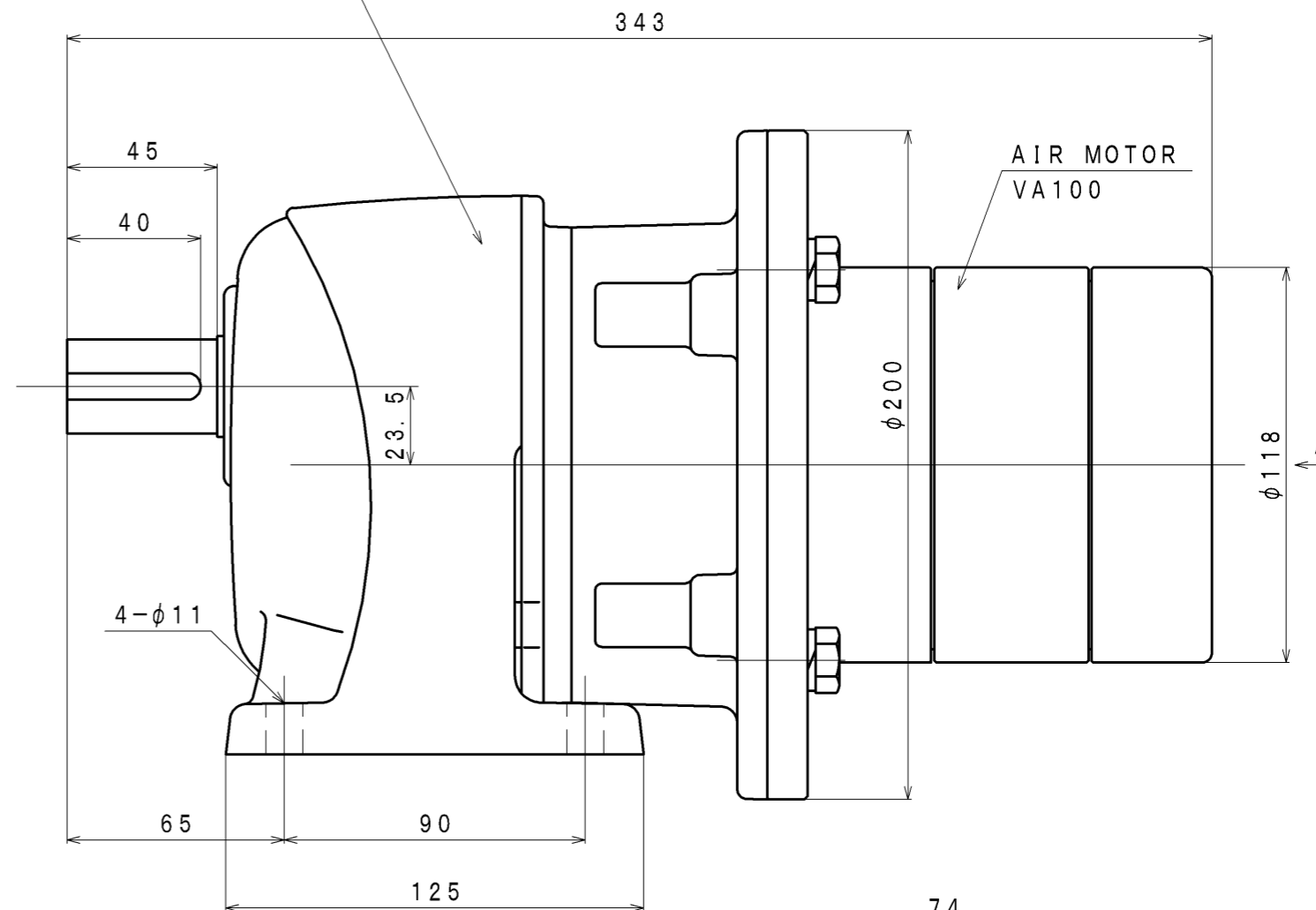

SPECIFICATION

AIR PRESSURE	AT MAXIMUM OUTPUT				※ ALLOWABLE SHAFT LOAD		LUBRICATING OIL	MASS
	OUTPUT	SPEED	TORQUE	AIR CONSUMPTION	RADIAL	THRUST	AIR MOTOR (Line Oiler)	
(MPa)	(kW)	(rpm)	(N·m)	(m ³ /min (nor))	(N)	(N)	△ JIS K2213-1 Turbine Oil ISO VG32 (Line Oiler Dripping Quantity:3~4 drop/min)	(kg)
0.6	0.78	98	76.0	1.52	1765	834		about 15.9
0.5	0.64	90	67.6	1.30				
0.4	0.51	81	60.0	1.08				

※: At Mid of Shaft

APPROVED	CHECKED	REVIEWED	DRAWN	PARTICULARS	OUTLINE DRAWING	DATE	APR. 27. 2009
M. M		W. S		MODEL	VA100R-B020	NOTE	
					AIR MOTOR	Z96-093	
SAN-EI SEIKI SEISAKUSHO CO., LTD.					DWG. NO.	E308-267	SCALE 1/2