

SIGN	REVISION	DATE	BY
△1	Renewal	111031	R. T
△2	Renewal, Correction	160405	W. S

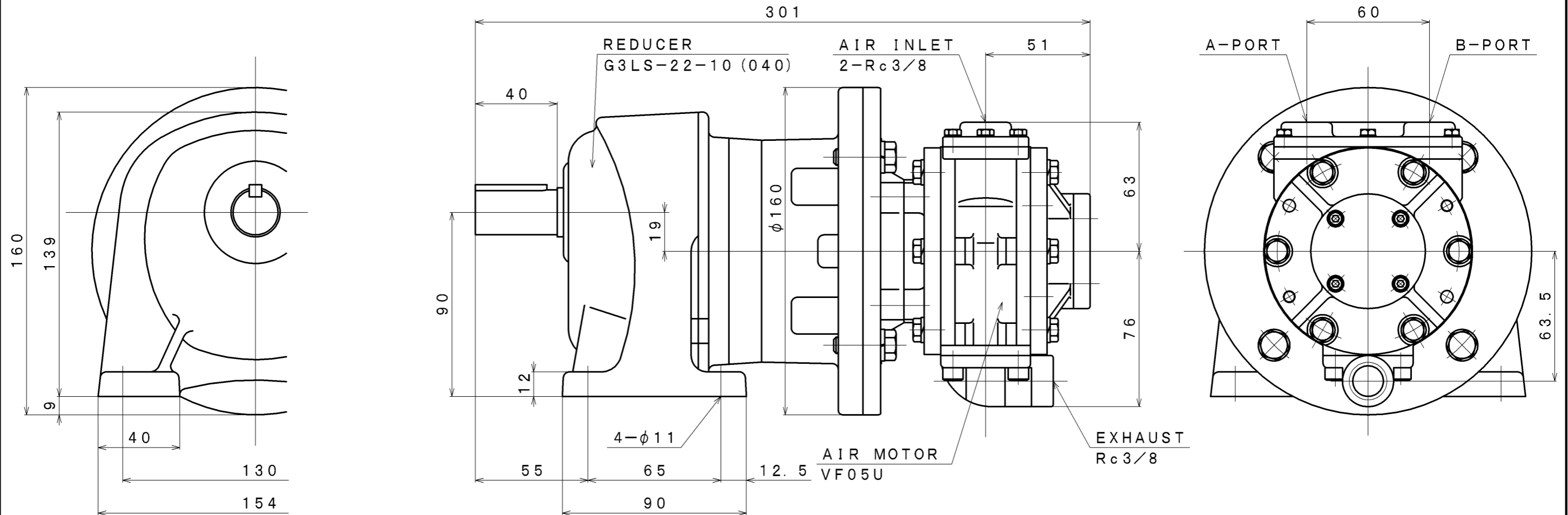
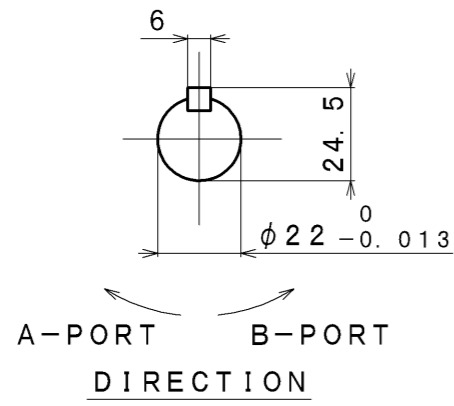

SPECIFICATION

AIR PRESSURE (MPa)	AT MAXIMUM OUTPUT				※ ALLOWABLE SHAFT LOAD		LUBRICATING OIL	MASS (kg)
	OUTPUT (kW)	SPEED (rpm)	TORQUE (N·m)	AIR CONSUMPTION (m ³ /min (nor))	RADIAL (N)	THRUST (N)	AIR MOTOR (Line Oiler)	
0.6	0.76	309	23.5	1.3	1180	127	△ JIS K2213-1 Turbine Oil ISO VG32 Line Oiler Dripping Quantity: 3~4 drop/min	about 9.7
0.5	0.65	288	21.5	1.1				
0.4	△0.51	268	△18.2	0.9				

※: At Mid of Shaft

APPROVED	CHECKED	REVIEWED	DRAWN	PARTICULARS	OUTLINE DRAWING	DATE	AUG. 31. 2010
M. S			W. S	MODEL	VF05U-L22-10	NOTE	
					AIR MOTOR	Z06-030	
SAN-EI SEIKI SEISAKUSHO CO., LTD.					DWG. NO.	E310-299	SCALE 1/2