

SIGN	REVISION	DATE	B Y
△1	Renewal	111031	R. T
△2	Renewal, Correction	160404	W. S

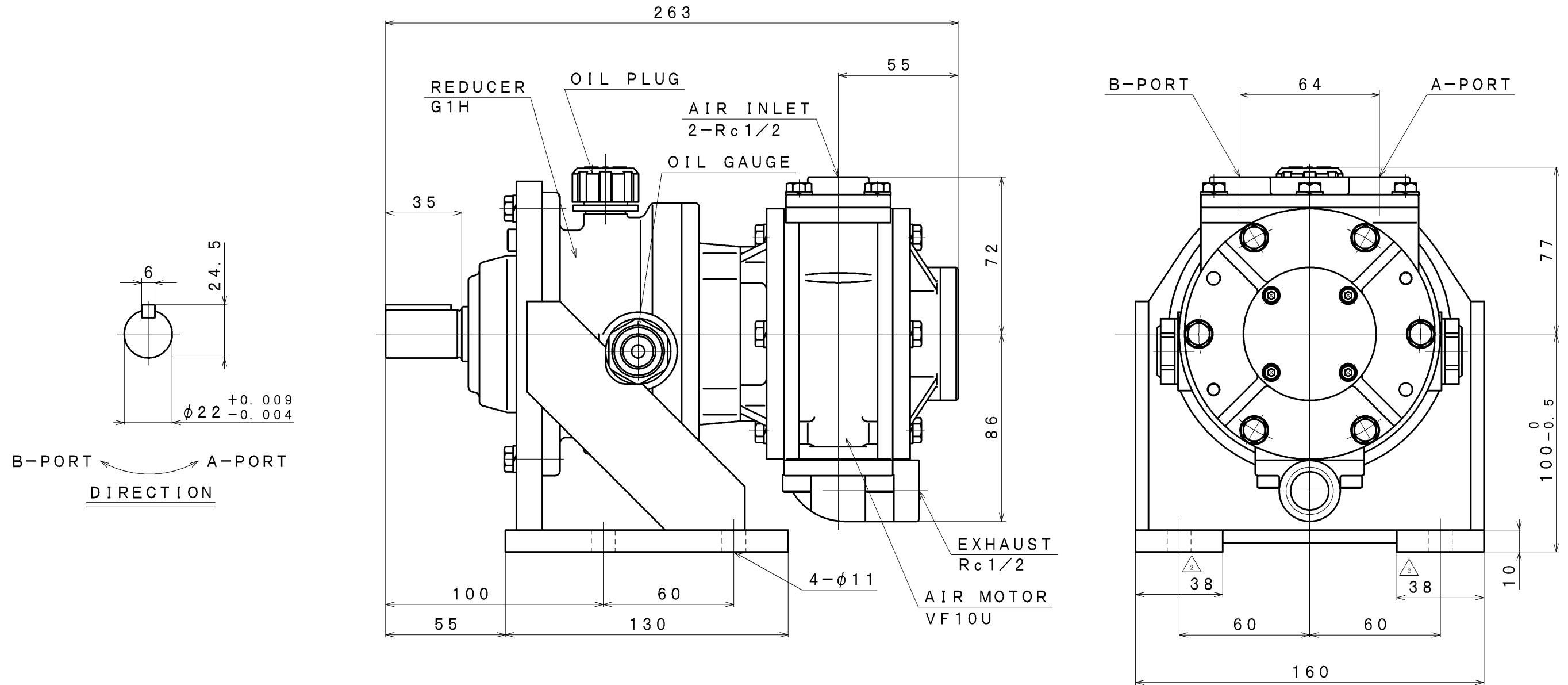

SPECIFICATION

AIR PRESSURE	AT MAXIMUM OUTPUT				* ALLOWABLE SHAFT LOAD		LUBRICATING OIL		MASS
	OUTPUT	SPEED	TORQUE	AIR CONSUMPTION	RADIAL	THRUST	AIR MOTOR	REDUCER	
(MPa)	(kW)	(rpm)	(N·m)	(m ³ /min (nor))	(kN)	(kN)	△ JIS K2213-1 Turbine Oil ISO VG32 Line Oiler Dripping Quantity: 4~5 drop/min	JIS K2219 Gear Oil ISO VG220 (60cc)	(kg)
0.6	1.03	509	19.3	1.7	0.9	0.2			about 13.6
0.5	0.87	473	17.5	1.5					
0.4	0.67	436	14.6	1.2					

*: At Mid of Shaft

APPROVED	CHECKED	REVIEWED	DRAWN	PARTICULARS	OUTLINE DRAWING	DATE	FEB. 12. 2010
M. M		W. S		MODEL	VF10U-G1H6B	NOTE	
					AIR MOTOR	Z06-045	
SAN-EI SEIKI SEISAKUSHO CO., LTD.					DWG. NO.	E310-102	SCALE 1/2