

SIGN	REVISION	DATE	B Y
△1	Renewal	111031	R. T
△2	Renewal	160405	W. S

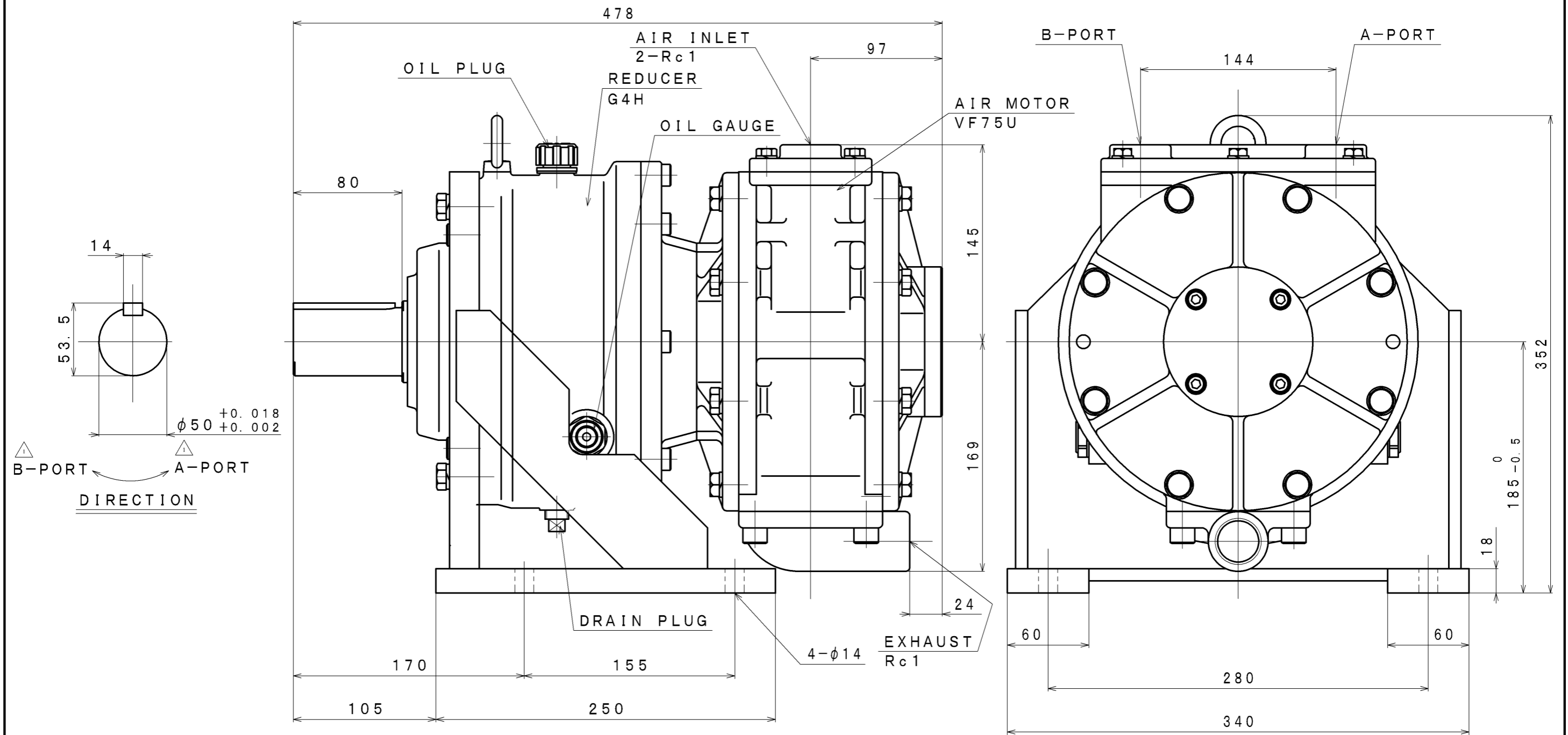

SPECIFICATION

AIR PRESSURE	AT MAXIMUM OUTPUT				※ ALLOWABLE SHAFT LOAD		LUBRICATING OIL		MASS
	OUTPUT	SPEED	TORQUE	AIR CONSUMPTION	RADIAL	THRUST	AIR MOTOR	REDUCER	
(MPa)	(kW)	(rpm)	(N·m)	(m ³ /min (nor))	(kN)	(kN)	△ JIS K2213-1 Turbine Oil ISO VG32 Line Oiler Dripping Quantity: 25~30drop/min	JIS K2219 Gear Oil ISO VG220 (320cc)	(kg)
0.6	7.89	206	364.4	10.0	4.0	0.8			about 103
0.5	6.27	181	331.3	9.0					
0.4	4.56	155	281.2	7.4					

※: At Mid of Shaft

APPROVED	CHECKED	REVIEWED	DRAWN	PARTICULARS	OUTLINE DRAWING	DATE	FEB. 17. 2010
M. M		W. S		MODEL	VF75U-G4H8B	NOTE	
					AIR MOTOR	Z06-055	
SAN-EI SEIKI SEISAKUSHO CO., LTD.					DWG. NO.	E310-125	SCALE 1/3